

OWNER'S MANUAL



VIDEO CASSETTE RECORDER

VCR-9688

G-CODE

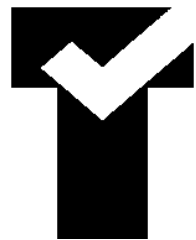

Type Tested
Electrical
Safety

AS/NZS 3250 Lic 4168
Standards Australia

How to Use This Manual

Please read this Owner's Manual carefully before using the VCR and store it in a safe place for future reference.

This Owner's Manual explains how to use your VCR and, in particular, using the remote control unit keys to control the VCR. Keys on the VCR itself that have the same label as their counterparts on the remote control unit perform exactly the same functions.

There is an "Identification of Controls" illustration on the back of this page. Use this if you are unsure of a key operation using the remote control unit or the display. To use this illustration, unfold this page as indicated in the diagram below and refer to the illustration while reading the appropriate section of the manual.

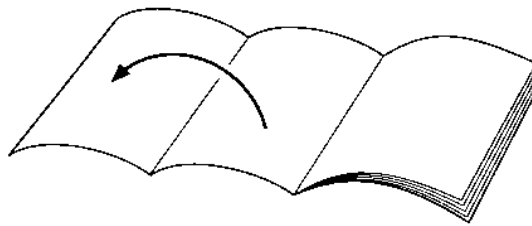

Remote control unit

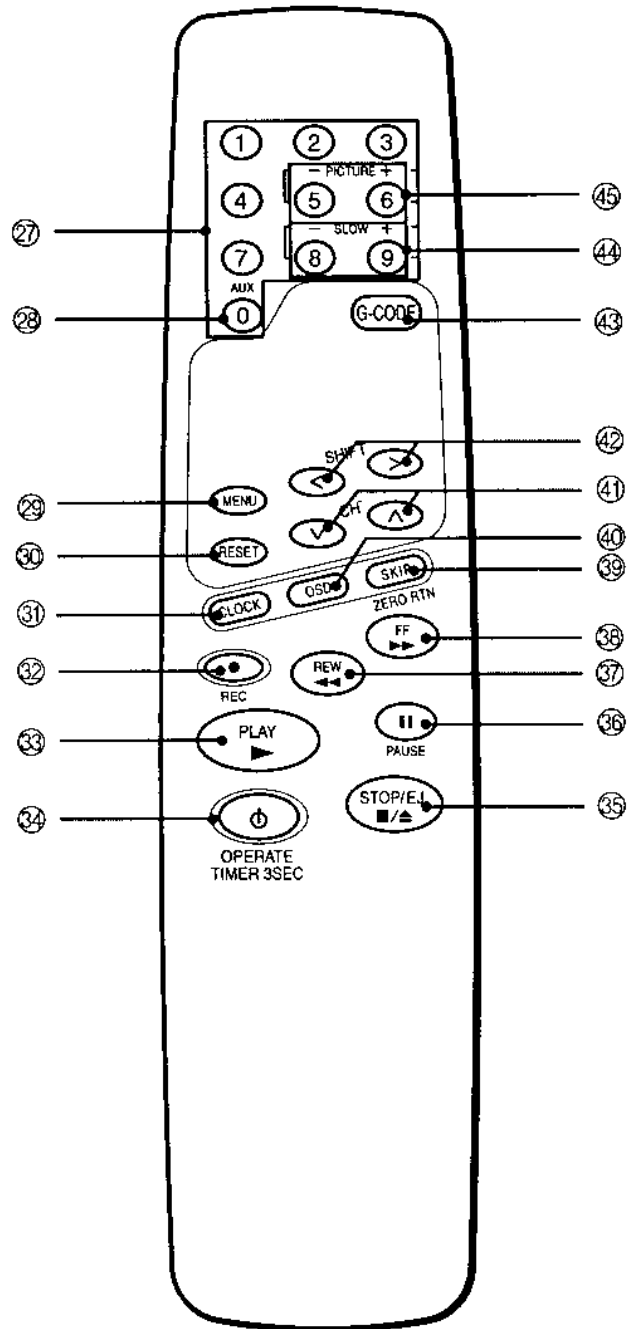

IDENTIFICATION OF CONTROLS

Front panel

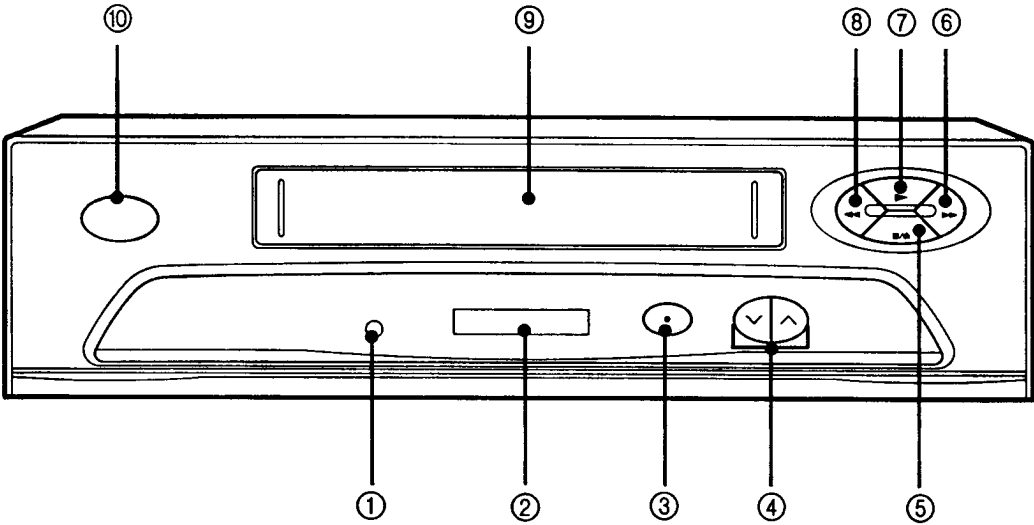

Rear panel

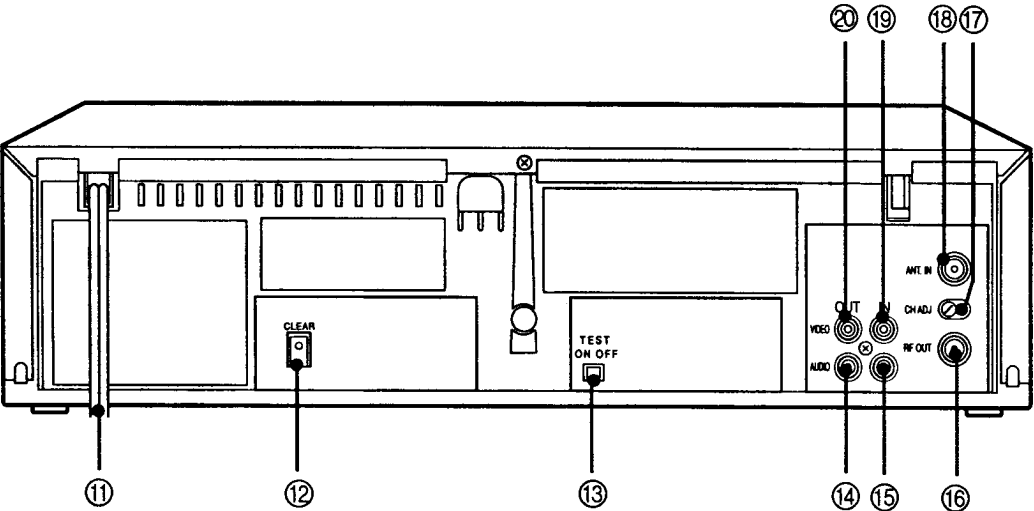

Multi-display

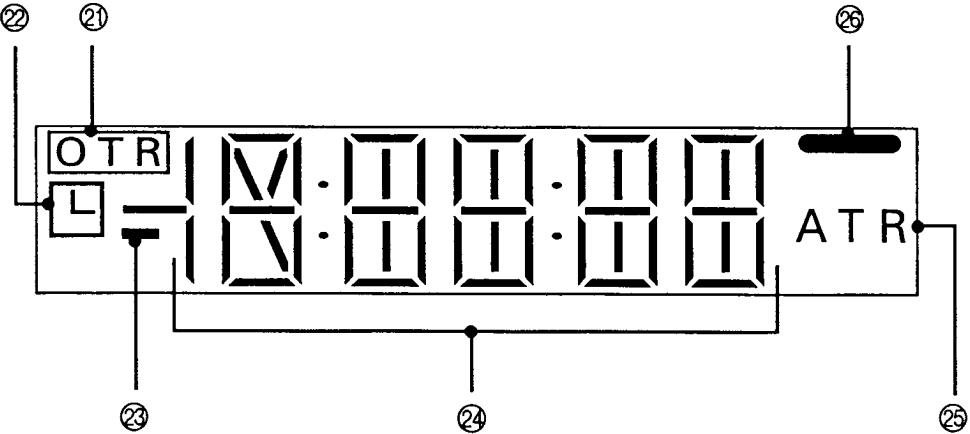



Front Panel

- ① REMOTE SENSOR
- ② Multi-display
- ③ REC.button (REC/OTR)
- ④ CHANNEL V/∧ buttons
- ⑤ STOP/EJECT button
- ⑥ FF button
- ⑦ PLAY button
- ⑧ REW button
- ⑨ Cassette loading slot
- ⑩ OPERATE/TIMER button

Rear Panel

- ⑪ AC Mains cord
- ⑫ CLEAR button
- ⑬ TEST SIGNAL switch
- ⑭ AUDIO OUT Jack
- ⑮ AUDIO IN Jack
- ⑯ RF OUT socket
- ⑰ CH ADJ (RF CHANNEL ADJUSTER)
- ⑱ ANT. IN socket
- ⑲ VIDEO IN Jack
- ⑳ VIDEO OUT Jack

Multi-display

- ㉑ One-touch timer recording indicator [OTR]
- ㉒ Timer set indicator []
- ㉓ REC indicator [—]
- ㉔ Operation mode indicator
(CH/TIME/COUNTER etc.)
- ㉕ Digital tracking indicator [ATR]
- ㉖ Power indicator []

Remote Control Unit

- ㉗ Number buttons (1-9, 0)
- ㉘ 0/AUX button
- ㉙ MENU-button
- ㉚ RESET button
- ㉛ CLOCK button
- ㉜ REC button
- ㉝ PLAY button
- ㉞ OPERATE/TIMER button
- ㉟ STOP/EJECT button
- ㊱ PAUSE button
- ㊲ REW button
- ㊳ FF button
- ㊴ SKIP/ZERO RTN button
- ㊵ OSD button
- ㊶ V CH ∨ buttons
- ㊷ < SHIFT > buttons
- ㊸ G-CODE button
- ㊹ SLOW button (8, 9)
- ㊺ PICTURE CONTROL button (5, 6)

CAUTION AND CARE

NOTICE:

Unauthorized recording of copyrighted television programmes, films, video tapes and other materials may infringe on the rights of copyright owners and be contrary to copyright laws.

WARNING:

TO PREVENT FIRE OR SHOCK HAZARD, DO NOT EXPOSE THIS EQUIPMENT TO RAIN OR MOISTURE.

CAUTION:

TO REDUCE THE RISK OF ELECTRIC SHOCK, DO NOT REMOVE COVER. NO USER-SERVICEABLE PARTS INSIDE. REFER SERVICING TO QUALIFIED SERVICE PERSONNEL.

CAUTION:

When the VCR is suddenly moved from a cold environment to a warm environment, some condensation will occur inside the VCR. If the VCR is operated as it is, the tape may stick to the tape head and damage to the tape and/or the deck will result. Under these circumstances, do not operate the VCR for about 2 hours with the Mains cord connected so as the VCR will dry out.

MAINTAIN GOOD VENTILATION

There are many ventilation holes on the bottom of the VCR. For maximum ventilation place the VCR on a hard level surface only.

DO NOT PLACE ANYTHING ON THE VCR

Heavy objects placed on the VCR will cause damage. The top of the VCR is also slotted to provide ventilation. Do not obstruct these ventilation slots.

NEVER INSERT ANY OBJECT INTO THE CABINET

Do not insert any kind of foreign object into the VCR. This not only creates a safety hazard but can also cause extensive damage to the mechanism.

PROTECT THE MAINS CORD

Do not damage the Mains Cord. Damage to the Mains Cord may cause a fire or shock hazard. When unplugging the Mains Cord, please hold by the plug and remove it carefully.

CABINET CARE

Clean with a soft cloth slightly moistened with a mild detergent and water. Wipe with a dry cloth.

NEVER USE ANY PETROLEUM BASE SOLUTIONS.

WHEN NOT IN USE

When you finish operating the VCR, always unload the cassette and turn OFF the OPERATE/TIMER button.

UNPLUG THE MAINS CORD AND DISCONNECT THE ANTENNA CABLES DURING A LONG ABSENCE

When you leave your home for a long period of time, turn OFF the OPERATE/TIMER button, unplug the Mains Cord and disconnect the antenna cables. Please note that on your return the calendar, clock data and channels will have to be reprogrammed.

For your reference, please record the serial number of your VIDEO CASSETTE RECORDER and the date you purchased it in the following space:

Serial Number: _____

Purchase Date: _____

CONTENTS

INTRODUCTION	E-4	Forward Search.....	E-13
RemoteControl Operation.....	E-4	Reverse Search.....	E-13
Video Cassette Tape.....	E-4	Still Frame	E-13
INSTALLATION	E-5	Frame Advance.....	E-13
Equipment Connection.....	E-5	SlowPlayback.....	E-13
TV Antenna.....	E-5	1 Minute Skip.....	E-14
Connection of VCR and TV Using		Zero Return.....	E-14
Audio/Video Connector.....	E-5	Blueback Function.....	E-14
Power Supply Cable.....	E-5	RECORDING	E-15
PREPARATIONS	E-6	Basic Operation.....	E-15
Video Channel Setting.....	E-6	Checking the Picture Being Recorded....	E-15
Initial Settings.....	E-6	Recording One Programme While	
Menu Screen/Mode Screen.....	E-8	Viewing Another.....	E-15
On Screen Display (OSD).....	E-8	Auto Turn on System.....	E-15
CHANNEL PRESETTING	E-9	Pause Function.....	E-15
AMS Operation.....	E-9	REC Review.....	E-15
Manual Tuning.....	E-9	Recording from Another VCR.....	E-15
Automatic Channel Changing.....	E-9	One-touch Timer Recording (OTR).....	E-16
Preparation for G-Code Instant Video		COUNTER FUNCTION	E-16
Programming.....	E-10	Counter Display.....	E-16
CHANNEL SELECTION	E-11	PROGRAMMABLE TIMER RECORDING	E-17
Tuning with the V CH \wedge Buttons.....	E-11	Before Programming.....	E-17
Tuning with the Number Buttons		Programming Procedure.....	E-17
(Remote Control Only).....	E-11	Hints on Programming.....	E-18
Selecting AUX Position.....	E-11	G-Code INSTANT VIDEO PROGRAMMING.	E-19
PLAYBACK	E-12	Before Programming.....	E-19
Basic Operation.....	E-12	Extending the Recording Time.....	E-19
Digital Tracking Control.....	E-12	G-Code Programming.....	E-19
Full Auto/Auto Playback System.....	E-12	About Error Messages.....	E-20
Auto Head Cleaner.....	E-12	OTHERS	E-21
SPECIAL EFFECT PLAYBACK	E-13	Specifications.....	E-22
Search.....	E-13		

ACCESSORIES

Before installing your VCR, please check you have the following items.

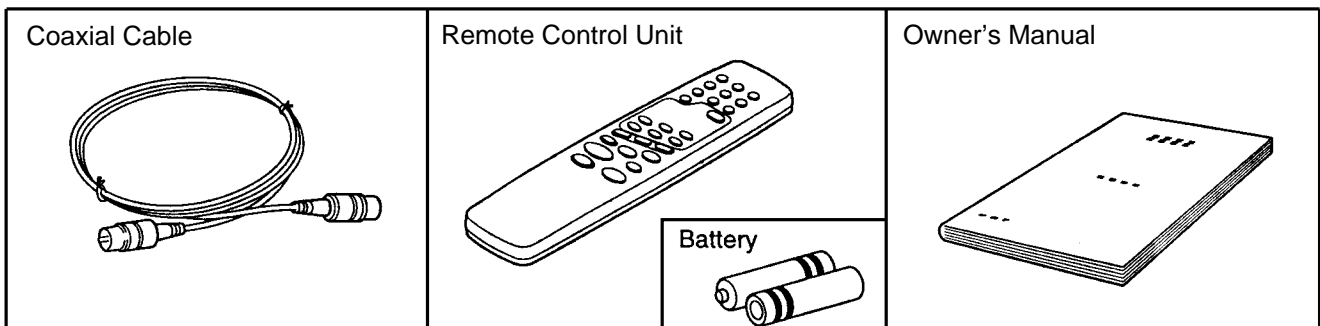

Moisture Condensation

Never operate this unit immediately after moving it from a cold location to a warm location. When the VCR is exposed to such a change in temperature, moisture may condense on the cylinder inside the machine. If the VCR is operated as it is, the tape may stick to the tape head and cause damage to the tape and/or the deck. Under these circumstances, do not operate the VCR for about 2 hours. Leave the power cord connected so that the VCR can dry out.

INTRODUCTION

Remote Control Operation

This VCR can be operated with the remote control from up to a distance of about 23 feet (7 meters) and within an angle of 15 degrees either side of center. There must be no obstacles between the remote control unit and the remote sensor of the VCR.

Battery Installation

- ① Remove the battery cover on the rear of the unit. (See Figure 1.)
- ② Install two size "AA" batteries into the battery compartment. (See Figure 2.)
- ③ Close the battery cover. (See Figure 3.)

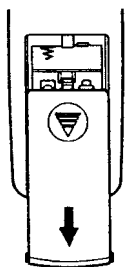

Fig. 1

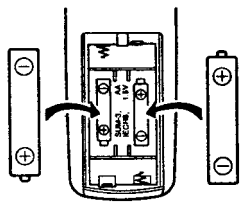

Fig. 2

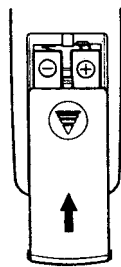

Fig. 3

Notes

- Be sure to install batteries properly to match the polarity diagrams drawn inside the battery compartment.
- Do not mix a new battery with an old one.
- Do not heat, disassemble, short or throw used batteries into a fire.

Precautions on Use

- Pressing two or more function buttons on the remote control unit at the same time may result in improper operation or damage.
- Do not place the remote control unit in an area where it may become wet.
- Do not place the remote control unit near high heat.
- Dropping the remote control unit on a hard surface may result in damage.
- Do not use benzene, thinner or other petroleum based solvent to clean the remote control unit. To clean, wipe a soft cloth slightly moistened with a mild detergent, and then wipe dry with a soft cloth.

Video Cassette Tape

Only the video cassette tapes marked with  can be used in this VCR.

A cassette tape cannot be loaded or unloaded unless the AC power cord is connected to the AC outlet.

Loading and Unloading

Loading

Insert a cassette tape with its labeled side up as shown in the cassette compartment. The cassette will be automatically drawn inside the compartment.

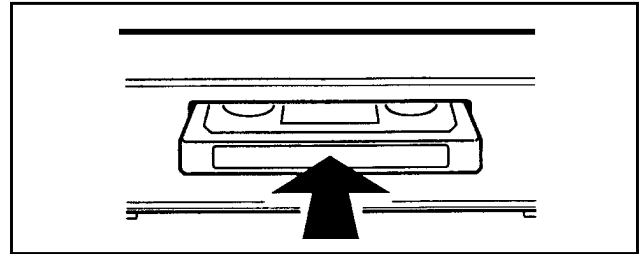

Unloading

- ① Press the STOP/EJECT button. The cassette will be ejected from the cassette compartment.
- ② Remove the cassette by pulling it toward you.

To Prevent Accidental Erasure

Every video cassette has a safety tab to prevent accidental erasure. Breaking off the safety tab is recommended for prevention from accidental erasure of the contents. If a tape without the safety tab is to be reused, cover the gap with a piece of adhesive tape.

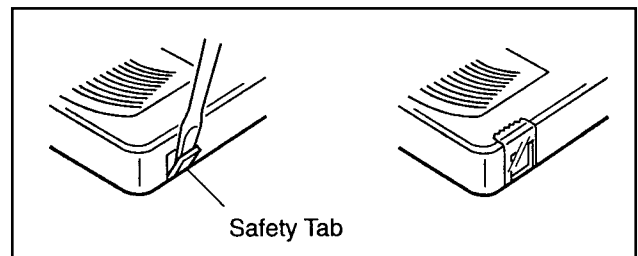

Tape Speeds and Maximum Recording Playback Time

TAPE SPEED	TYPE OF THE VIDEO CASSETTE TAPE			
	E-300	E-180	E-120	E-60
SP (Standard Play)	5hrs	3 hrs	2 hrs	1 hr

Care of the Video Cassette Tape

- Avoid violent vibration or shock.
- Do not place in a location where strong magnetic fields exist (near a motor, transformer or magnet).
- Never place or store in direct sunlight.
- Avoid dusty places,
- Place the cassette in the cassette case and store vertically.
- Never store tape in a humid location.

INSTALLATION

Equipment Connection

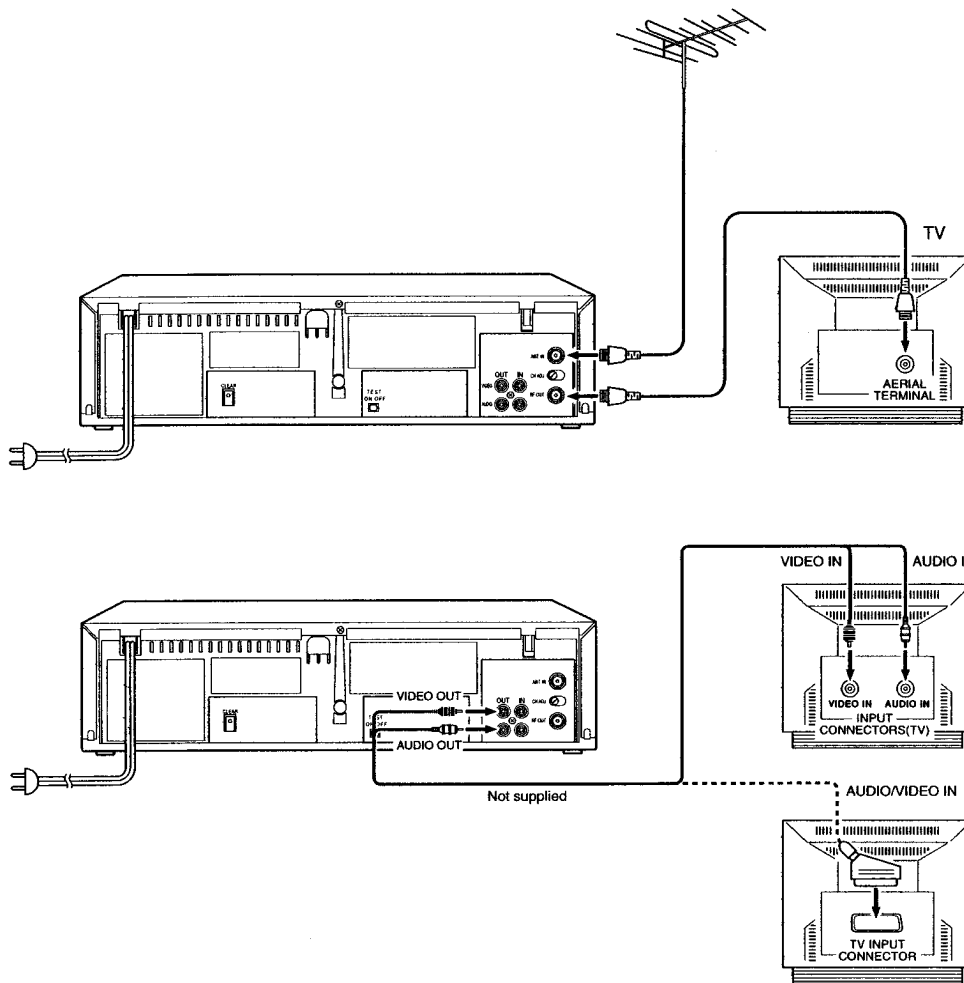

TV Antenna

To watch a picture from the VCR using this connection, it is necessary to set one of the TV channels as the "Video channel". See Preparations in Video Channel Setting (on Page 6).

1. Connect the antenna (or CATV) connector to the ANT. IN socket.
2. Connect the accessory coaxial cable between the RF OUT socket and the TV.

Connection of VCR and TV Using Audio/Video Connector

In this case use the A/V mode specified on your TV, instead of UHF channel 32 or another unoccupied channel.

Power Supply Cable

Connect to a wall AC outlet.

PREPARATIONS

Video Channel Setting

This setting is necessary for RF connections (when the SCART cable is not used to connect this unit and the TV). This setting is not necessary for AV connections using the SCART cable. Start from the initial Settings in the next section.

1. Switch on the test signal switch on the rear panel of the main unit.
2. Press the OPERATE/TIMER button and switch on the power for the VCR.
3. Switch on the power for the TV and select the TV channel 32 so that the test picture is clearly displayed on the TV.
If channel 32 of your TV is occupied, select another unoccupied TV channel eg. between channels 30 and 39.
4. If the TEST screen does not appear or not clear, use a small screwdriver and turn the RF channel adjustment (CH ADJ) on the rear panel so that the test picture is clearly displayed on the TV.
5. Switch off the test signal switch on the rear panel of the main unit.

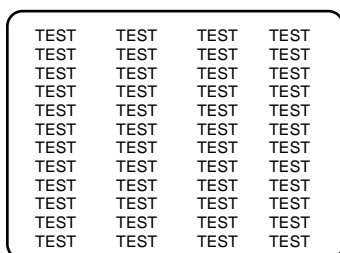

Initial Settings

When the video channel setting is complete and you press the OPERATE/TIMER button to switch on the power, the on-screen language setting screen appears as the first of the initial settings. Set the initial settings in the order below.

• Order for initial Settings

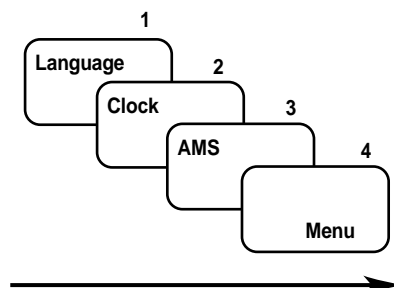

1 On-screen Language Setting

↓ You can select one of five languages (English, German, French, Italian, Spanish) to be used for the OSP display.

2 Clock Setting

↓ Timer recording and other such functions require that the current time (hour and minute) and date (day, month, year) be set.

3 AMS (Auto Memory System)

↓ This automatically stores the channels in memory and assigns positions.

4 Ends (the unit returns automatically to the Menu screen.)

Note

If you press the **OPERATE/TIMER** button to turn off while setting the initial settings, the next screen is displayed when the power is turned on again.

1. Set the On-screen Language

• Initial Setting Up

1. Select the language you want by using the **VCHA** buttons to display it inverted.
2. When you press the MENU button, that language is set and the CLOCK SET screen appears automatically.

• Changing the Language after the Initial Settings

1. Press the MENU button and call up the menu screen.
2. Select the language you want with the **VCHA** buttons.
3. When you press the MENU button, the selected language is set and the unit returns to the Menu screen.

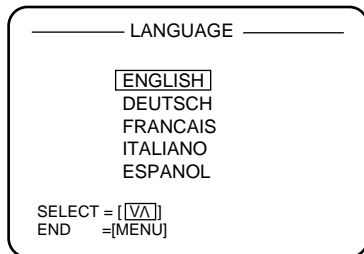

2. Clock Setting

• Initial Setting Up

Using the **VCHA** buttons

1. Select summer time in and out, then set this with the SHIFT > button.
2. Select the hour and minute and set them with the SHIFT> button.
3. Select the day and month and set them with the SHIFT > button.
4. Select the year and set it with the SHIFT > button.
5. When you press the MENU button, the clock starts. Next the AMS screen appears.

• Changing the Time after the Initial Setting

1. Press the MENU button to call up the menu screen, select CLOCK SET with the **VCHA** buttons, then press the SHIFT> button.
2. Change the time according to Steps 1.-4 in the initial settings.
3. When you press the MENU button the clock starts and the unit returns to the Menu screen.

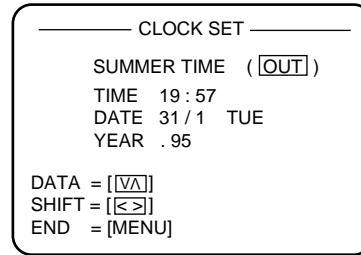

<-(OUT)-> (IN):

One hour automatically added to time

(IN)-> (OUT):

One hour automatically subtracted from time

Notes

- When setting dates after 29th, set the month first.
- The <SHIFT> button can be used to move items.

3 AMS (Auto Memory System)

• Initial Setting Up

1. Press the SHIFT> button to start AMS.
2. AMS ends automatically and the unit returns to the Menu screen.

• To Execute AMS again after the Initial Setting

1. Press the MENU button to call up the menu screen, select AMS with the **VCHA** buttons, and press the SHIFT > button.
2. If you execute AMS, the position data programmed in the initial settings is cleared.
3. To execute AMS, press the SHIFT> button. (The data previously stored in memory is cleared and AMS is executed again.) To cancel AMS, press the MENU button.

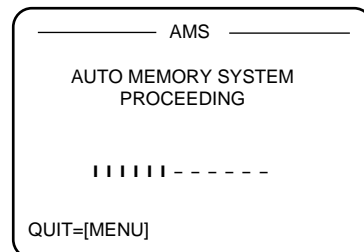
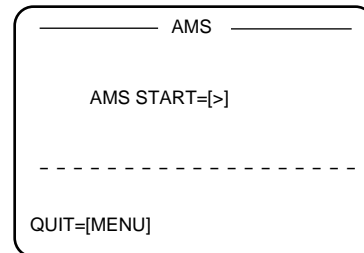

Note

If the power to the unit is cut off because of a power failure or the plug being unplugged from the socket, the initial settings must be made again. However, the channel preset memory is retained.

Menu Screen/Mode Screen

• Using the Menu Screen

When you press the MENU button, the menu screen is called up. When you press the MENU button again, the unit returns to the normal screen.

Select the item you want by using the **VCHA** buttons to highlight its screen setting, then press the **SHIFT>** button to move to the selected screen.

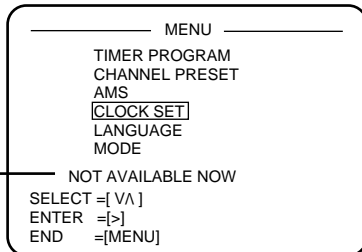

<-- See Page 17.
<-- See Page 9.
<-- See Page 9.
<-- See Page 7.
<-- See Page 7.

When AU position is selected, or during playback or recording, the CHANNEL PRESET and AMS screen cannot be selected. This message will appear, and the normal TV screen will be restored.

• Using the Mode Screen

Select the item you want by using the **VCHA** buttons, then press the **SHIFT>** button. Set the data you want by using the **VCHA** buttons.

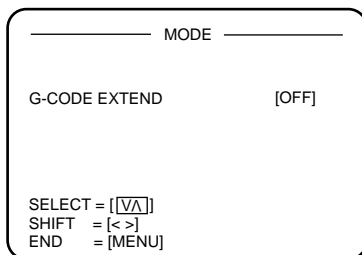

<-- (OFF) - (5MIN).

On Screen Display (OSD)

You can display the on-screen information which tells you the tape operation mode, the channel selected, the recording speed, the tape count, or the time.

To call up the on-screen information, press the OSD button. All information is displayed. Press the button again to turn the display off.

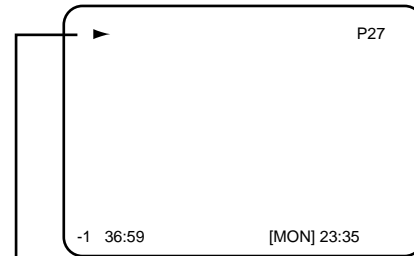

▶ : PLAY
▶▶ : FF
◀◀ : REW
■ : STOP
○ : REC
▬ : PAUSE
▲ : EJECT

Even if the VCR is in OSD off mode, the superimposed information will appear on the TV screen and multi-display for a few seconds when you press any tape operation button or when you select a channel. After a few seconds, it disappears from the screen. When OSD is on, the on-screen information remains on the screen.

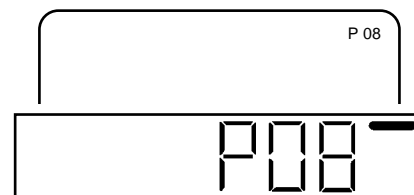
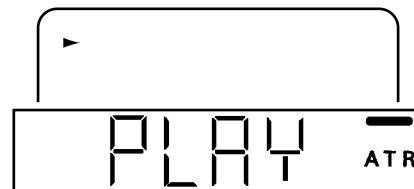

CHANNEL PRESETTING

There are two ways to preset channels: Automatic tuning with AMS and manual tuning.

AMS Operation

Automatic tuning with AMS is executed during the initial settings, so normally it is not necessary. AMS is necessary at such times as when you take the unit to another region. See Initial Settings 3 AMS (Auto Memory System) on Page 7.

Manual Tuning

Manual tuning is used when there is a channel that was not preset by AMS or when you want to swap the channel at any position.

1. Press the MENU button to call out the menu screen Using the **VCHA** buttons
2. Select CHANNEL PRESET and press the SHIFT> button. The channel preset screen appears.
3. Only five positions are displayed on the screen. Select the number of the position to be changed and press the SHIFT> button. The picture for the selected channel is displayed while the OSD button is being pressed.
4. Select the channel and press the SHIFT> button.
5. Select whether or not this channel is to be skipped when you move through the channels with the **VCHA** buttons (yes: skipped; no: not skipped), then press the SHIFT> button.
6. To add or change other positions, repeat Steps 3.-5.

Automatic Channel Changing

If a channel you have placed at some position already exists at another position, those channels and their skip settings are automatically swapped.

Example:

If you changed from Channel 022 to Channel 045 at Position 02, since Channel 045 is already at Position 01 Channel 022 is swapped to Position 01.

CHANNEL PRESET		
POS	CH	SKIP
01	045	NO
02	022	YES



CHANNEL PRESET		
POS	CH	SKIP
01	045	YES
02	022	NO

CHANNEL PRESET		
POS	CH	SKIP
01	002	NO
02	* 022 *	NO
03	045	NO
04	101	YES
05	121	YES

← YES: Skipped
NO: Not Skipped

Display while a channel is being tuned.

SELECT =[V \]
ENTER =[>]
END =[MENU]

CHANNEL SELECTION

Tuning with the V CH \wedge Buttons

1. Press the OPERATE/TIMER button to turn on the VCR.
2. Press the **VCHA** buttons to select the position number to which the desired channel has been preset.



Notes

- If the **VCHA** buttons are pressed and immediately released, the preset position steps up or down and the corresponding channel is tuned.
 - If the **VCHA** buttons are held in for longer than 0.5 second, the position numbers will keep changing until the button is released.
-

Tuning with the Number Buttons (Remote Control Only)

For channels preset in single-digit position
Press the 0 button, then the corresponding number button (1 to 9) within three seconds.

For channels preset in two-digit position

1. First enter the ten's digit with one of the NUMBER buttons 1-9
2. Then enter the one's digit within 3 seconds with the NUMBER buttons 1-9 and 0

Notes

- If you select a position with no assigned channel, it is not valid, and the previous channel will reappear.
 - If you wait more than 3 seconds to enter the second digit, the first digit will disappear and the previous position number will reappear.
 - Even when "SKIP" is set to "NC" on the CHANNEL PRESET Screen (see page 9) it is possible to select channels with the NUMBER Button.
-

Selecting AUX Position

The AUX (auxiliary input) position (displayed as "AU") may be selected with the 0/AUX button. When the AUX position is selected, recording from an external A/V source may be performed with the AUDIO/VIDEO socket.

- Press the 0/AUX button twice to select the AUX position.

PLAYBACK

Basic Operation

1. Press the OPERATE/TIMER button.
2. Insert a cassette tape into the CASSETTE LOADING SLOT.
3. Turn on the TV and select the channel for video viewing.
4. Press the PLAY button to start playback.

To stop playback:

Press the STOP/EJECT button.

To rewind a tape in Stop mode:

Press the REW button.

To advance a tape rapidly in Stop mode:

Press the FF button.

To stop fast forwarding or rewinding:

Press the STOP/EJECT button.

Digital Tracking Control

Auto tracking

When playback starts or playback speed is changed during playback, VCR enters Auto tracking mode. At this time, the indication ATR blinks on the multi-display for a few seconds.

Manual tracking

If video noise appears in the picture after putting the VCR into Auto tracking mode, use the Manual tracking adjustment function. Press the **VCHA** buttons until the best possible picture is obtained.

To return to Auto tracking mode, press the PLAY button for more than 2 seconds.

Notes

The noise on the screen may not be completely removed depending on the tape used, especially when the tape has been recorded on another VCR.

Picture Control (Video Enhancer)

During playback, press the NUMBER button 5 or 6 to obtain desired picture enhancement.

To make the picture softer, press the NUMBER button 5. To make the picture sharper press the NUMBER button 6.

The enhancement level is indicated by figures (-9 to 9) on the Multi-display.

Auto Rewind System

When a tape reaches its end in Playback, Fast Forward or Record mode except OTR and Programme Timer Recording, it will be automatically rewound to its beginning and the unit will be switched to Stop mode.

Full Auto/Auto Playback System

Full Auto Playback

Simply insert a cassette tape without a safety tab into the VCR while the unit is turned off. The following operations will be performed automatically:

1. The VCR is turned on and the tape starts to playback.
2. The tape is rewound to the beginning when it reaches the end.
3. The tape is ejected and the VCR is turned off.

Auto Playback

Auto Playback is used when the VCR has already been turned on.

1. The tape starts to playback.
2. The tape is rewound to the beginning when it reaches the end. The VCR is not turned off.

Notes

The Auto Playback or Full Auto Playback mode will be released if one of the tape related buttons (FF, REW, PAUSE, STOP/EJECT, PLAY or OPERATE/TIMER) is pressed.

Auto Head Cleaner

This VCR is equipped with an Automatic Video Head Cleaner. This feature will ensure that your VCR always performs at its best by keeping the video heads clean of dirt that can distort picture quality. The Auto Head Cleaner engages automatically each time a tape is inserted or ejected.

SPECIAL EFFECT PLAYBACK

Search

The Picture Search function is a convenient way to locate a desired portion of the tape quickly.

Forward Search:

To view high-speed pictures in the forward direction

1. In the Playback mode, press the FF button.
2. Press the FF button again to search faster.
3. To resume normal playback, press the PLAY button.

Reverse Search:

To view high-speed pictures in the reverse direction

1. In the Playback mode, press the REW button
2. Press the REW button again to search faster.
3. To resume normal playback, press the PLAY button

Notes

- The audio output is muted during picture search operation.
 - Noise bars may appear on the picture during picture search. This does not indicate a malfunction of the VCR.
 - Press the **VCHA** buttons in the course of Forward Search or Reverse Search to move noise bars up and down for the best screen.
-

Still Frame

To freeze the picture

1. In the Playback mode, press the PAUSE button to freeze the picture.
2. To resume normal playback, press the PLAY button.

Notes

- If the VCR is left in Still mode for longer than five minutes, it will automatically release Still mode to prevent damages to the tape.
 - The audio output is muted in Still mode.
 - A noise bar will appear during the still frame. Please note that this is normal.
-

Frame Advance

Each time you press the PAUSE button in still mode the still picture advances one frame.

Slow Playback

1. Press the NUMBER 8 button or the NUMBER 9 button to perform slow playback.
2. Each time these buttons are pressed, the playback speed changes.
3. Press the **VCHA** buttons during Slow Playback to move noise bars up and down. Press the PAUSE button when the screen gets the best condition to make a still frame. When the **VCHA** buttons are continuously held in such a situation, the shake of the picture screen will be stopped.
4. To return to normal play, press the PLAY button.

Notes

A noise bar will appear during slow playback. Please note that this is normal.

1 Minute Skip

With this feature you can skip over one minute's worth of commercials recorded on a tape.

- Pressing the SKIP/ZERO RTN button in Play mode to forward search the tape for 60 seconds, then returns the VCR to Play mode.
 - Pressing the SK/P/ZERO RTN button while it is fast forwarding through the commercials (Skip mode) will return the VCR to Play mode.
-

Zero Return

In Stop mode, this rewinds the tape until the counter setting is 0:00:00

- During Play mode, press the RESET button to set the counter to 0:00:00 at a scene you wish to watch again. When you have finished watching the tape, pressing the STOP/EJECT button then the SKIP/ZERO RTN button causes the VCR to fast forward or rewind until the counter setting is 0:00:00
-

Blueback Function

If an empty channel is selected or a blank section of tape is encountered in Play mode, the TV screen automatically changes to a solid blue color. The screen will remain blue until an active channel is selected or a recorded signal is again detected.

RECORDING

Basic Operation

1. Press the OPERATE/TIMER button.
2. Press the **VCHA** buttons to select a desired channel to be recorded.
3. Insert a cassette tape with a safety tab.
4. Press the REC button to start recording.
5. To finish recording, press the STOP/EJECT button.

Checking the Picture Being Recorded

Turn on the TV and tune to the channel for video viewing.

Notes

- If a cassette without a safety tab is inserted, it will automatically eject when the REC button is pressed. This protects the recorded contents on tape against accidental erasure.
- If the tape reaches its end during recording, it will be automatically rewound to its beginning and the unit will be switched to Stop mode.
- In the Pause mode, it is possible to change a channel.

Recording One Programme While Viewing Another

1. Press the OPERATE/TIMER button.
2. Set the TV for normal TV viewing and select the channel to be viewed.
3. Select a desired channel to be recorded with the **VCHA** buttons.
4. Insert a cassette tape with a safety tab.
5. Press the REC button to start recording.
6. To finish recording, press the STOP/EJECT button

Auto Turn on System

When a cassette tape with a safety tab is inserted with the VCR turned off, the VCR will be automatically turned on.

Pause Function

To stop recording momentarily

1. Press the PAUSE button during recording.
2. To release the pause mode and resume recording, press the REC button

REC Review

During normal recording (excluding timer recording and OTR), pressing the PAUSE button causes the VCR to rewind and display the last half second of the recording. This allows you to check a recording while it is being recorded.

Recording from Another VCR

With this VCR, you can make recordings from an external source, e.g. copying onto this VCR from a second VCR.

1. Connect another VCR or an external equipment to this VCR.
2. Press the 0/AUX button twice so that the line input indicator "AU" appears.
3. Play the tape on VCR A for playback and press the REC button on VCR B.

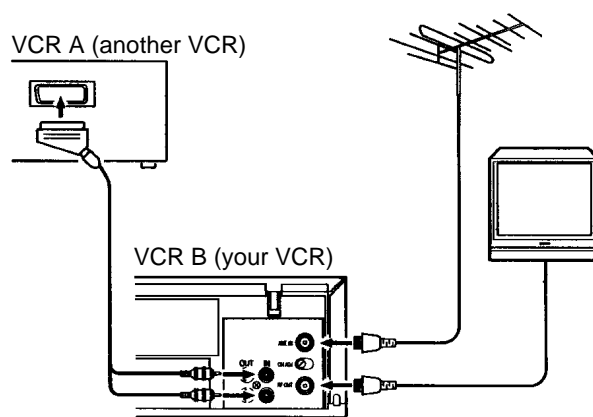

One-touch Timer Recording (OTR)

This allows you record for up to 5 hours with automatic turn-off.

1. Press the REC button during recording.
The VCR enters OTR mode.
2. Select the recording duration by pressing the REC button repeatedly. The OTR indication appears on the TV screen.
The OTR recording will start immediately.

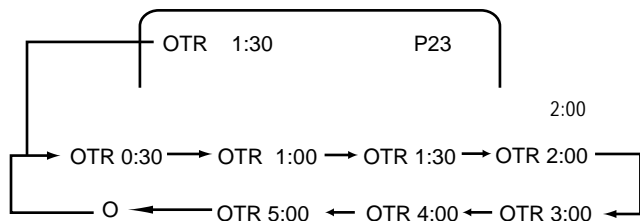

Notes

If the REC button is pressed during OTR recording, the remaining recording time is indicated on the TV screen and is automatically reduced.

Changing OTR Duration

The OTR duration can be changed by pressing the REC button even after the OTR recording has started.

When the REC button is pressed once, the next recording duration is selected.

- e.g. When the remaining recording time is 13 minutes, the indication changes:

0:13 → 0:30 → 1:00 →

Notes

- If the tape reaches its end during OTR recording, it will be automatically stopped and the unit will be turned Off.
- When OTR recording has finished, the VCR will automatically switch to Timer Recording Standby mode if there is Timer program data.

COUNTER FUNCTION

Counter Display

When a cassette tape is inserted, the counter display appears. The counter starts counting up or down when the PLAY, REC, FF or REW button is pressed.

Notes

The counter display automatically reverts to the clock display when the unit is turned off or a cassette tape is ejected.

CLOCK/COUNTER Display Switching

To change the counter display to the clock display, press the CLOCK (clock/counter) button.

Counter Display



Clock Display



Counter Reset

To reset the counter to "0:00:00", press the RESET button.

PROGRAMMABLE TIMER RECORDING

A maximum of 8 events can be programmed within a period of one month including the present day for timer recording.

A timer recording can be activated at the same time on the same day every week, on every day or on weekdays, as well as on a particular day.

Program example

Current time and date August 20, 1995 (Sunday), 10:20 am

This example records Channel 32 stored in memory at Position 07 on Program Set No. 2 from 7:30 PM until 8:25 p.m. on August 23rd (Wednesday).

Before programming

- Check that a tape cassette with the safety tab in place is inserted in the unit.
- Check that the clock is set correctly.

Programming procedure

1. Press the MENU button to call up the menu screen.
2. Press the SHIFT > button to call out the timer program screen.
 - The items to set blink inverted. For each item, press the **VCHA** buttons to select the appropriate data. When you press the SHIFT> button to enter that data, the next item blinks. If there is no need to select that item, press the SHIFT> button to move to the next item.
3. Set the program set number.
4. Set the date.
5. Set the starting time.
6. Set the ending time.
7. Set the channel position. When recording an external input source, set AU with the **VCHA** buttons.
8. To program for another program set number, repeat Steps 3.-7.
9. Press the MENU button to end the program. The unit returns to the menu screen.

If you hold down the OPERATE/TIMER button for more than three seconds, the unit goes on timer standby. Check that the multi display indicator [**Q**] lights up. To cancel this mode, hold the OPERATE/TIMER button down for three seconds again.

Child lock

During timer standby mode, all button functions are blocked except MENU button. To cancel this mode, hold the OPERATE/TIMER button down for three seconds.

Correcting a programme

Press the SHIFT </> buttons, during programming, to return to the item to be corrected, then correct it by selecting the appropriate data again with the buttons.

Cancelling a programme

If you press the RESET button during programming, the data for the program set number being set is cleared.

TIMER PROGRAM				
NO.	DATE	START	STOP	POS
1				
2	23/ 8	19 : 30	20 : 25	04
3				
4				

1 2 3 4 5 6 7 8

SELECT =[V \]
ENTER =[>]
END =[MENU]

Checking a Programme

- While the timer is standing by
Press the MENU button. The programme confirmation screen is displayed. After checking the programme, press the MENU button again to return to the normal screen.
While the timer is recording
- Press the MENU button. The programme confirmation screen is displayed and the programme line being recorded blinks. After checking the programme, press the MENU button again to return to the normal screen.

Hints on Programming

In Step 4, you can select various "EV" (every week) recording of the same channel at the same time modes as well as recording on a particular day. Press the V button when the current day on the calendar blinks or press the Λ button, exceeding the last day of the calendar (the day after one month). The DATE indication on the data set line will change in sequence.

EV-SU...EV-SA:

Recording on every specified day of the week.

MO-FR: Recording every weekday

→ : changes with Λ button

← : changes with V button

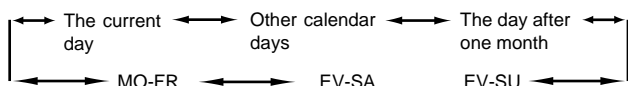

When a timer recording is executed, the programmed data except for the everyday or weekly recording is erased.

If a power failure occurs or the power cord is unplugged, the programmed data will be erased. (However, the programmed data will last for 20 minutes). Reset the date and clock and re-programme the timer for recording.

Notes on Timer Settings

- The VCR will turn on 20 seconds prior to the programmed recording start time and enter pause mode. Timer recording starts on time.
- If the cassette has no safety tab when you press the OPERATE/TIMER button to put the VCR in timer recording standby mode, the cassette will be automatically ejected.
- TIMER Recording Standby mode will not be activated when the OPERATE/TIMER button is pressed for three seconds under the following conditions.
 - * There is not video cassette in the VCR.
 - * There is no programmed data.

When two programmes overlap

- If the start of the later programme overlaps with the recording period of the earlier programme, the earlier programme will be recorded to the end and then the later programme will be recorded. This means that the later programme will not be recorded during the overlapped period.

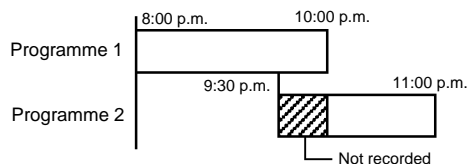

- If the same start time is set on two or more programmes, the programme with the lowest number has the priority over the other programmes and will be recorded to the end. Then the programme with the next lowest number will be recorded. This means that the other programmes will not be recorded during the overlapped period.

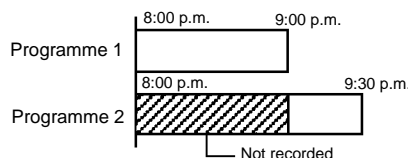

G-Code INSTANT VIDEO PROGRAMMING

G-Code program can record a program by using the G-Code numbers (up to 9 digits) in newspaper and magazine TV listings to set the VCR.

G-Code is a trademark applied for by Gemstar Development Corp. G-Code system is manufactured under license from Gemstar Development Corporation.

Before Programming

- Make sure that the clock on the VCR is set to the correct time.
- Make sure that a blank video tape with a safety tab has been inserted into the VCR.

Extending the Recording Time

To extend the recording time beyond the setting of the G-Code programming, follow the steps below.

1. Press the MENU button to call up the menu screen.
2. Select "MODE" and press the SHIFT > button to call up the mode screen.
3. Use the **VCHA** buttons to select "G-CODE EXTEND" and press the SHIFT> button.
4. Press **VCHA** buttons to change the setting to "5 MIN".
5. Press the MENU button twice to end the setting.

Note

The recording time cannot be extended after a G-Code program has been set. Always extend the recording time before setting a G-Code recording time.

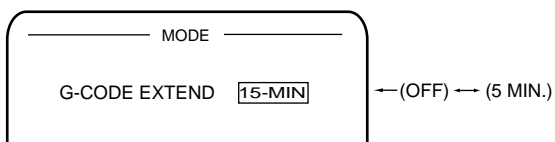

G-Code Programming

1. Press the G-CODE button to call up the G-Code screen.

Note

If 8 programs have already been scheduled, you cannot program a G-Code schedule.

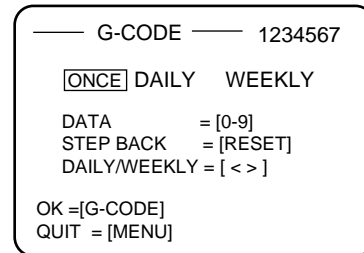

2. Enter the G-Code number on the newspaper or magazine TV listing.
For example, if the G-Code number is 123456789, enter 123....
Look at the screen to make sure that the number has been entered correctly.

Correcting a number

A digit is deleted with each press of the RESET button. Delete digits until the incorrect number has been deleted, then enter the correct numbers.

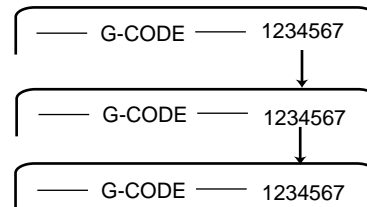

3. Press the SHIFT> button to select the recording mode (ONCE, DAILY or WEEKLY).
ONCE: on a particular day
DAILY: at the same time every day (MO-FR)
WEEKLY: at the same time on the same day every week

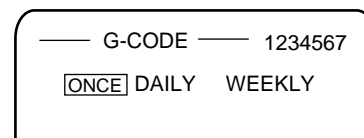

4. Press the G-CODE button.

- Use the screen below to check the settings. If this is the first time G-Code has been used for a channel, use the **VCHA** buttons to enter the position number. Refer to the table on page 10 for details. This setting is only required the first time. The POS settings can be changed. Use the < SHIFT > buttons to select the item and press the **VCHA** buttons to change the settings. To cancel the settings, press the RESET button.

— G-CODE — 1234567	
DATE	31/12
START	20:00
STOP	23:45
POS	<input type="checkbox"/>
OK	= [G-CODE]
CANCEL	= [RESET]
DATA	= [VA] SHIFT = [< >]

Notes

- The channel position programmed the first time the G-Code function is used, is automatically displayed from the second time.
- If the POS setting is changed, the new setting is used until it is changed again.

- Check that all the settings are as you wish then press the G-CODE button. The Timer Program screen appears for few seconds. Then the VCR returns to the normal screen.

Notes

A program cannot be set while the POS indicator is . Always use the **VCHA** buttons to select a position number.

This completes the procedure for G-Code program, Press the OPERATE/TIMER button for 3 seconds, or longer, to enter Timer Stanby mode. To cancel this mode, hold the OPERATE/TIMER button down for three seconds again.

About Error Messages

- If the G-Code number is incorrect**
"ERROR" and the G-Code number blink. Then correct a G-Code number follow the procedure for "Correcting a number" on the previous page.
- If the G-Code number and the recording mode do not match. For example, a program on a Saturday or Sunday is scheduled for DAILY (MO-FR) recording.**
"ERROR" and "DAILY" blink and the recording mode is forcibly set to ONCE.

— G-CODE — 1234567	
ONCE	<input type="checkbox"/> DAILY WEEKLY
	<input type="checkbox"/> ERROR

OTHERS

Check the following list of problems and remedies before calling service personnel. The problem may be one you can solve yourself.

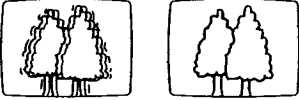
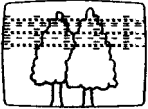
SYMPTOM	CAUSE	REMEDY
No power supply to the VCR.	AC Mains Cord is not connected.	Connect the AC Mains cord to the AC outlet.
Power is on but the VCR does not operate.	Dew condensation inside the VCR.	Leave the VCR with the AC mains cord connected. (It takes approximately 2 hours for the VCR to dry out)
Poor picture or no picture on TV during Playback or recording.	TV channel is not set to the video channel.	Set the TV channel to the correct one.
 <p>Picture shakes No colour</p>	The video channel of the TV is not fine tuned.	Fine tune the video channel of the TV set.
	Connections between the TV and the VCR are not properly made.	Check these connections and connect them correctly.
	Noise in the picture during playback.	The video heads are dirty.
	The tracking adjustment is bad.	Adjust the tracking using the VCHA buttons
	The cassette tape is old and/or defective.	Replace with a new one.
	Noise bars, poor or no colour on pause mode.	This is normal on PAUSE mode and is not a fault condition.
The REC button does not operate.	The safety tab of the cassette is removed	Place a piece of adhesive tape over the gap.
	The tape has run out.	Replace with another one with sufficient length.
Recording does not complete.	The tape has run out during recording.	Replace with a new one.
	More than one programme has been preset within the same preset	Re-programme the information.
No timer recording.	The programmed data is not correct.	Re-programme data correctly.
	The active channel is not tuned with the built-in tuner of VCR.	Select the channel on which the broadcasting programme is aired.
	The VCR is not ready for timer recording.	Hold down the OPERATE/TIMER button more than 3 seconds to illuminate timer indicator.
	Clock indicates inaccurate time.	Set clock to the current time.
No remote control unit operation.	Not operated in the proper operation range.	Use the remote control unit within the operation range.
	An obstacle exists between the remote control unit and the VCR.	Remove the obstacle.
	Batteries are exhausted or dead.	Replace them with new ones.
	Battery polarities are incorrect.	Insert batteries correctly.
Correct indication does not appear in the display panel.		Clear the data stored in the unit's memory with the CLEAR button and input data again.

SPECIFICATIONS

GENERAL SECTION

Power Requirements	230V AC ~ 50 Hz
Power Consumption	16 Watts
Dimensions (W x H x D)	370 x 95.5 x 271 mm
Weight	Approx. 3.6 kg.
Operating Temperature	5°C to 40°C
Operating Humidity	35% to 80% R. H.
Video Recording System	2 Rotary Heads, Helical Scanning System
Number of Video Heads	2 Heads
Tape Speed	23.39 mm/sec. (SP)
Tape Format	VHS 1/2-inch PAL Cassette Tape
Record/Playback Time	Up to 5 Hours with E-300 tape

VIDEO SECTION

Television System	PAL: 625 Lines, 50 Fields, Colour Signal
Modulation System	Luminance: FM Azimuth Recording Colour Signal: Converted Subcarrier Phase Shift Recording
Horizontal Resolution	Colour : 230 Lines, Nominal
Input Level	1 Vp-p 75 Ω , unbalanced
Output Level	1 Vp-p 75 Ω , unbalanced
Signal-to-Noise Ratio	More than 43dB

AUDIO SECTION

Input Level	300m Vrms, 50K Ω , Unbalanced
Output Level	300m Vrms, 1K Ω , Unbalanced
Audio Track	1 Track
Signal-to-Noise Ratio	More than 36dB
Frequency Response	100 Hz to 6KHz

Design and specifications are subject to change without notice for performance improvement.

PALSONIC CORPORATION PTY LTD
1 JOYNTON AVENUE
WATERLOO NSW 2017 AUSTRALIA
TEL:(02)9313 7111
FAX:(02)9313 7555
www.palsonic.com.au

**PALSONIC CUSTOMER SERVICE
TELEPHONE
AUSTRALIA: 1300 657 888**